

# RYNO<sup>®</sup> DINING TABLE → FLOOR FASTENING

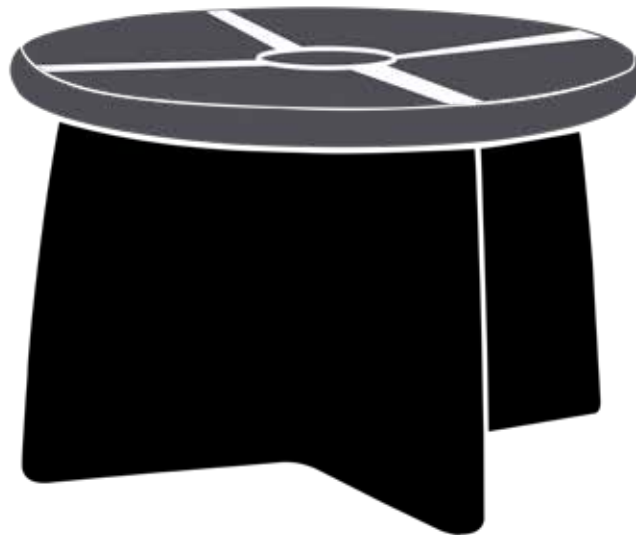

*These instructions apply only when fixing to a concrete floor with no obstructions (e.g. under floor heating, cables, plumbing, etc.). When fixing to any other surface, or with obstructions, please contact your Pineapple representative for further advice*

## REQUIRED ITEMS

- 2 x fixing plates  
*(only provided with floor fixed version)*
- 4 x M10x20 security screws  
*(only provided with floor fixed version)*
- 4 x floor fixing bolts  
*(only provided with floor fixed version)*
- 1 x handheld power drill
- 1 x masonry drill bit
- 1 x drill bit holder
- 1 x T45 security drill bit
- Wrench/socket set
- Hammer

# RYNO<sup>®</sup> DINING TABLE → FLOOR FASTENING

01

Turn the table upside down on a clean surface, laying the table on a furniture blanket to protect the table

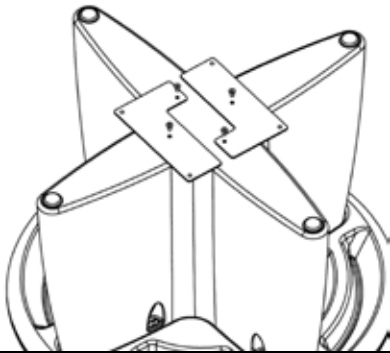
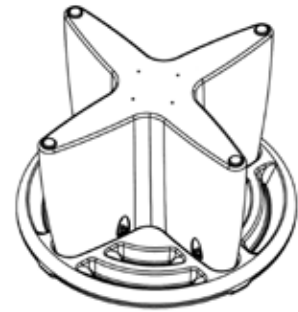

Position fixing plate over the threaded inserts on the bottom of the table so that the countersunk holes are in line with the inserts. Using your fingers, screw the bolts through the plate and into each insert

02

03

Once you have all bolts in position, use the drill to tighten them down. The plate should now be in position and secure. Repeat the process with the remaining fixing plate on the other side

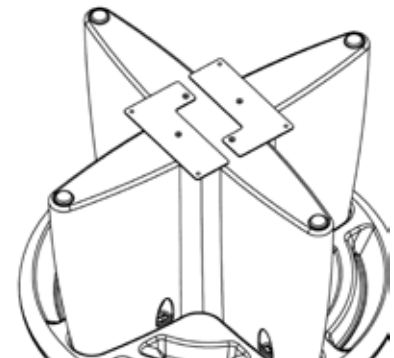

Set product into required position and mark off the centre of each position to be drilled through the fixing plate

04



T  
E

800.496.9324

[inquiries@pineapplecontracts.com](mailto:inquiries@pineapplecontracts.com)

**Pineapple**

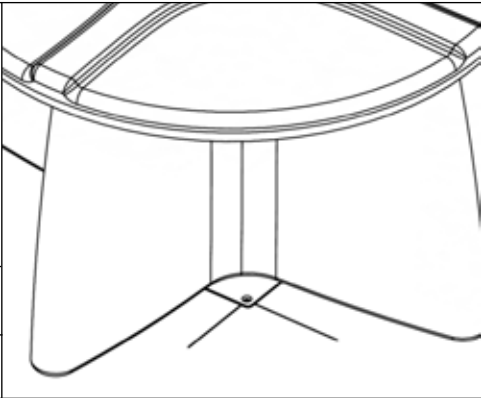
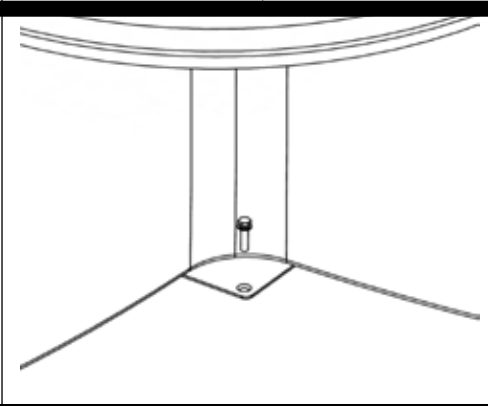
# RYNO<sup>®</sup> DINING TABLE → FLOOR FASTENING

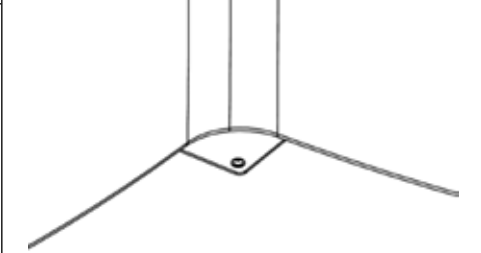
<h2>05</h2>	<p>Move the product to one side and drill out the marked drill points to the required depth using masonry drill bits (drill a pilot hole to begin with using a smaller bit). Carefully tap the floor fixing bolts into each drilled hole using a hammer</p>	
	<p>Remove the top nut from each bolt, place the product into position over the exposed threads, then re-screw each nut back onto the bolt threads and tighten down by hand. The collar on each bolt should feed into the hole on the fixing plate</p>	<h2>06</h2>
		
<h2>07</h2>	<p>Once you have all the nuts securely in place, use a wrench and socket to tighten each nut down until the nut head shears off from the domed cap</p>	



800.496.9324

[inquiries@pineapplecontracts.com](mailto:inquiries@pineapplecontracts.com)

**Pineapple**

# DISCLAIMER

	<ul style="list-style-type: none"><li>→ Ensure the proper and adequate hardware is used to secure furniture</li><li>→ Ensure fastenings are appropriate for the anchoring material</li><li>→ Use fastenings of an appropriate strength and consider using security fixings in challenging environments</li><li>→ Consider using high strength thread-locker on fastenings in challenging environments</li><li>→ Ensure all gaps are sealed with the appropriate anti-pick mastic after product installation if necessary</li><li>→ Please read all instructions carefully to ensure proper installation. Failure to read and follow instructions may result inadequate product installation and void of warranty</li><li>→ Pineapple shall not be held liable for any consequences caused by the improper installation of products to the installer or the end user</li></ul>



800.496.9324

[inquiries@pineapplecontracts.com](mailto:inquiries@pineapplecontracts.com)

